

■ Close View of NEW LEC series Features



●LED light support



●Widen shoulder strape with soft pad which gives the tool easy operate



●Ergonomic design and comfortable to use with anti-slip coated grip



●Power indicator
● Active / standby
☀ Power is on
☀ Power is low
☀ Overcurrent protection



●Bosch battery power indicator 14.4V Li-ion battery

■ **Model No. LEC-25** (with Li-ion Battery & Charger)

Height : 335 mm
Weight : 5.2 kgs (battery included)

■ **Specifications:**

Drive unit : 14.4V DC Motor
Charger (GS/CE) :
Input voltage : 110V Single Phase AC
Input voltage : 230V Single Phase AC
Input frequency : 50-60 Hz
Input current : 21.75 VA
Reservoir capacity : 120 cc

■ **Crimping Capacity:**

Max. Pressure : 450 bar
Max Output : 4.8 tons / 47 kN
Crimping Die Sets As Below
(Sold Separately)



※ 3 CRIMPING JAWS ARE SOLD SEPARATELY.

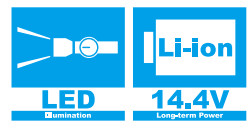

■ Model No. **LEC-25 Die Set**

Weight : 3.0 kgs

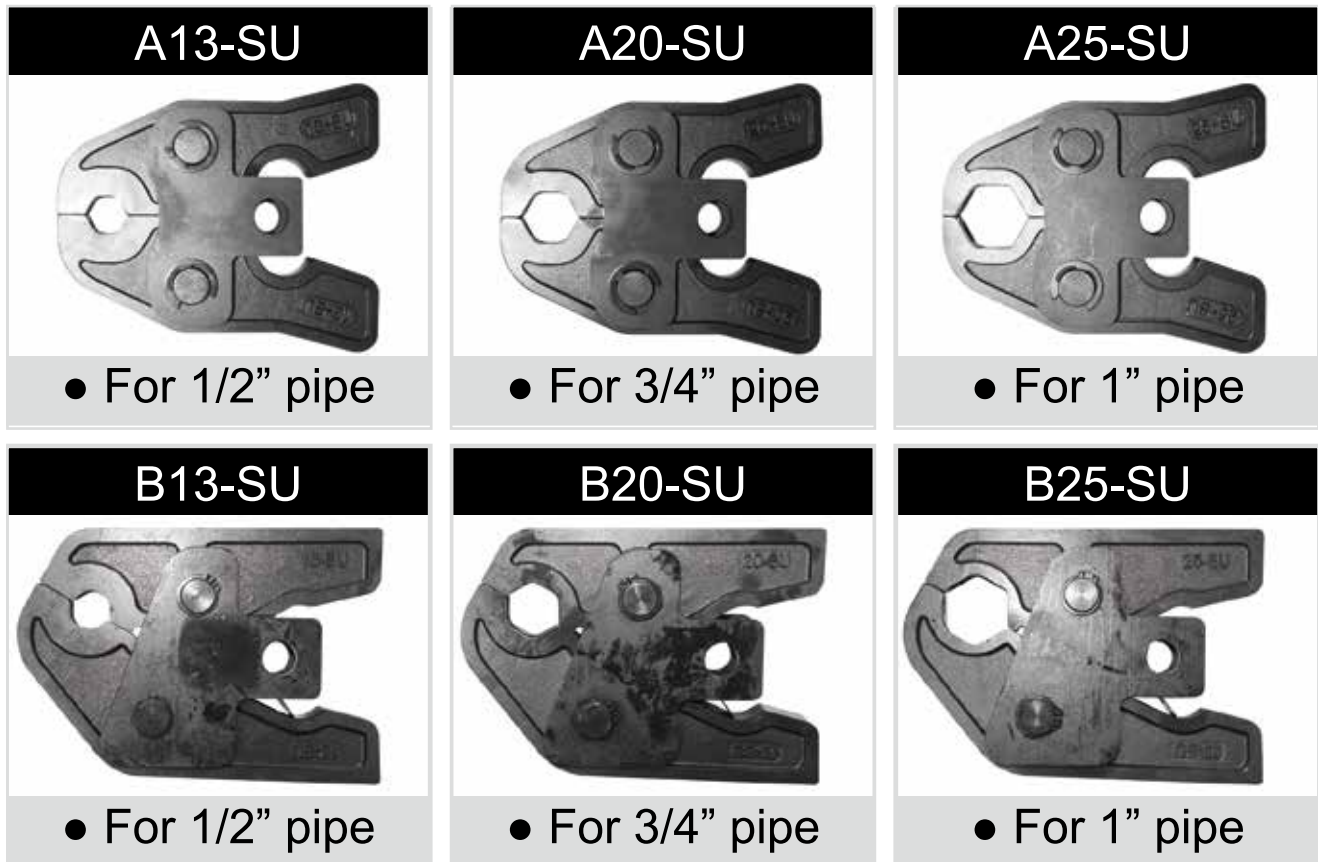

※(Standard JIS G3448)

■ Exchange The Die Set Operate Procedure



■ **Model No. LEC-185T** (with Li-ion Battery & Charger)

Length : 310 mm

Weight : 4.6 kgs (battery included)

■ **Specifications:**

- Drive unit : 14.4V DC Motor
- Charger (GS/CE):
- Input voltage : 110V Single Phase AC
- Input voltage : 230V Single Phase AC
- Input frequency : 50-60 Hz
- Input current : 21.75 VA
- Reservoir capacity : 145 cc

■ **Crimping Capacity:**

- Max Pressure : 460 bar
- Max. Output : 5.3 tons / 52 kN
- Max. Compression : 185 mm² copper
- Accepts BEKU type dies
- Stock Dies are for DIN 46235 Terminals
- Dies sold separately (See page 151)
- (AHE 1016 / 2535 / 5070 / 95120 / 150 / 185)

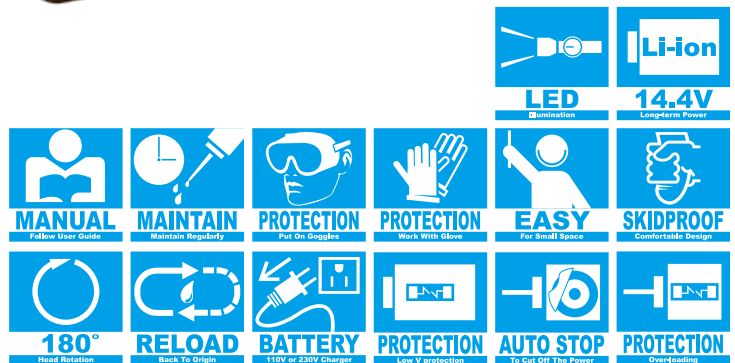

BATTERY OPERATED TOOLS

■ Model No. **LEC-240T** (with Li-ion Battery & Charger)

Height : 360 mm

Weight : 4.9 kgs (battery included)

■ Specifications:

Drive unit : 14.4V DC Motor
 Charger (GS/CE):
 Input voltage : 110V Single Phase AC
 Input voltage : 230V Single Phase AC
 Input frequency : 50-60 Hz
 Input current : 21.75 VA
 Reservoir capacity : 145 cc

■ Crimping Capacity:

Max Pressure : 550 bar
 Max. Output : 5.3 tons / 52 kN
 Max. Compression : 240 mm² copper
 Accepts BEKU type dies
 Stock Dies are for DIN46235 Terminals
 Dies sold separately (See page 151)
 (AHE 1016 / 2535 / 5070 / 95120 / 150 / 185 / 240)

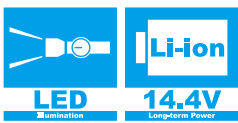

■ **Model No. LEC-U26** (with Li-ion Battery & Charger)

Height : 378 mm
Weight : 5.0 kgs (battery included)



■ **Specifications:**

Drive unit : 14.4V DC Motor
Charger (GS/CE) :
Input voltage : 110V Single Phase AC
Input voltage : 230V Single Phase AC
Input frequency : 50-60 Hz
Input current : 21.75 VA
Reservoir capacity : 120 cc

■ **Crimping Capacity:**

U-Type Head
Crimping force : 12.7 tons / 125 kN
Main Applications :
Cu conductors : 400 mm²
Al conductors : 240 mm²
C sleeves connector : 120 mm²



HEXAGONAL	INDENT TYPE	TERMINAL	C-CONNECT	SPEED DELIVERY	MANUAL Follow User Guide	MAINTAIN Maintain Regularly	PROTECTION Put On Goggles	PROTECTION Work With Glove	EASY For Small Space	SKIDPROOF Comfortable Design	LED Illumination	14.4V Long-term Power
330° Head Rotation	RELOAD Back To Origin	BATTERY 110V or 230V Charger	PROTECTION Low V protection	AUTO STOP To Cut Off The Power	PROTECTION Low V protection	330° Head Rotation	RELOAD Back To Origin	BATTERY 110V or 230V Charger	PROTECTION Low V protection	AUTO STOP To Cut Off The Power	PROTECTION Low V protection	PROTECTION Overloading

■ Model No. **LEC-U27** (with Li-ion Battery & Charger)

Height : 323 mm

Weight : 7.0 kgs (battery included)

■ Specifications:

Drive unit : 14.4V DC Motor

Charger (GS/CE):

Input voltage : 110V Single Phase AC

Input voltage : 230V Single Phase AC

Input frequency : 50-60 Hz

Input current : 21.75 VA

Reservoir capacity : 120 cc

■ Crimping Capacity:

U-Type Head

Crimping force : 12.7 tons / 125 kN

Main Applications :

L.V lugs & splices : 400 mm²

Insulated Terminals : 240 mm²

C sleeve connector : 185 mm²

H.V.lugs & splices : 400 mm²

Al lugs 7 splices : 300 mm²

Dies sold separately (See page 151)

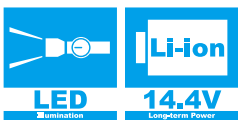

■ Model No. **LEC- 150** (with Li-ion Battery & Charger)

Length : 354 mm

Weight : 5.4 kgs (battery included)

■ Specifications:

Drive unit : 14.4V DC Motor
 Charger (GS/CE):
 Input voltage : 110V Single Phase AC
 Input voltage : 230V Single Phase AC
 Input frequency : 50-60 Hz
 Input current : 21.75 VA
 Reservoir capacity : 152 cc

■ Crimping Capacity:

Max. Pressure : 700 bar
 Oil Required : 31 cc
 Crimping force : 12.7 tons / 125 kN
 Main Application : Up to 150mm² CU

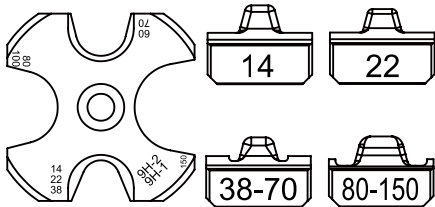

BATTERY OPERATED TOOLS

■ Model No. **LEC-32** (with Li-ion Battery & Charger)

Height : 328 mm

Weight : 7.0 kgs (battery included)

■ Specifications:

Drive unit : 14.4V DC Motor

Charger (GS/CE):

Input voltage : 110V Single Phase AC

Input voltage : 230V Single Phase AC

Input frequency : 50-60 Hz

Input current : 21.75 VA

Reservoir capacity : 120 cc

■ Crimping Capacity:

Jaw opening : 32mm

Crimping force : 12.7 tons / 125 kN

Main Application : Up to 400mm² CU

Dies sold separately (See page 151)



- Insulated cap should be ordered separately.

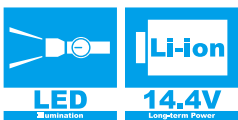

Accepts all dies used by Alcoa, Burndy, T&B, Klauke, Cembre and Blackburn 12 ton U-type dies. Suitable for TERMINALS with wall thickness little less than DIN 46235 cable lugs.





■ **Model No. LEC-40** (with Li-ion Battery & Charger)

Height : 387 mm
Weight : 6.8 kgs (battery included)

■ **Specifications:**

Drive unit : 14.4V DC Motor
Charger (GS/CE) :
Input voltage : 110V Single Phase AC
Input voltage : 230V Single Phase AC
Input frequency : 50-60 Hz
Input current : 21.75 VA
Reservoir capacity : 120 cc

■ **Crimping Capacity:**

Jaw opening : 40 mm
Crimping force : 12.7 tons / 125 kN
Main Application : Up to 400mm² CU
Dies sold separately (See page 151)



Accepts all dies used by Alcoa, Burndy, T&B, Klauke, Cembre and Blackburn 12 ton U-type dies. Suitable for TERMINALS with wall thickness little less than DIN 46235 cable lugs.

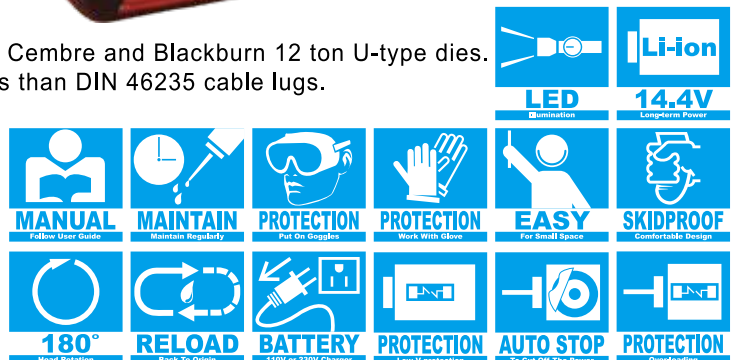

BATTERY OPERATED TOOLS

■ Model No. **LEC-44** (with Li-ion Battery & Charger)

Height : 363 mm

Weight : 7.8 kg (battery included)

■ Specifications:

Drive unit : 14.4V DC Motor

Charger (GS/CE):

Input voltage : 110V Single Phase AC

Input voltage : 230V Single Phase AC

Input frequency : 50-60 Hz

Input current : 21.75 VA

Reservoir capacity : 205 cc

■ Crimping Capacity:

Jaw opening : 44mm

Crimping force : 12.7 tons / 125 kN

Main Application : Up to 400mm² CU

Dies sold separately (See page 151)



- Insulated cap should be ordered separately.

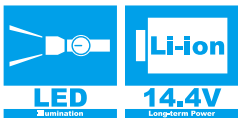

Accepts all dies used by Alcoa, Burndy, T&B, Klauke, Cembre and Blackburn 12 ton U-type dies. Suitable for TERMINALS with wall thickness little less than DIN 46235 cable lugs.





■ **Model No. LEC-45X** (with Li-ion Battery & Charger)
Weight : 5.0 kgs (With Battery, w/o any head)

■ **Specifications:**

- Drive unit : 14.4V DC Motor
- Charger (GS/CE) :
- Input voltage : 110V Single Phase AC
- Input voltage : 230V Single Phase AC
- Input frequency : 50-60 Hz
- Input current : 21.75 VA
- Reservoir capacity : 120 cc

■ **Crimping Capacity:**

- LEC-45X can be transformed with 6 different adapter heads as Cable Cutter \ Puncher \ Crimper \ Bus Bar Cutter \ Nut Splitter \ Puncher.
- Max Output : 12.7 tons / 125 kN
- Ram Stroke : 44 mm



※ 6 ADAPTER HEADS ARE SOLD SEPARATELY.

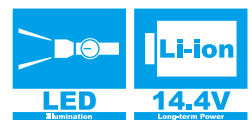

■ Model No. **LEC-44X / LEC-45X (Related heads)**

44AT-Hex (Hex. Crimping Head Adapter)

Main Application : 10-400 mm²
Die sold separately : 16, 25, 35, 50, 70, 95, 120,
150, 185, 240, 300, 400 mm²
Accept all 12 tons die sets



44AT-50AP (Panel Punching Head Adapter)

Punching Capacity :
Mild Steel Panel thickness : 7mm / Dia : 17.5mm
Copper Panel thickness : 7mm / Dia : 20.5mm
Included Round Punching Die Sets :
10.5, 13.5, 17.5, 20.5 mm each set for mild steel.
**Die sets for copper panel sold separately.



44AT-NC36 (Nut Splitter Head Adapter)

Bolt Range : M10~M24
Hex. Nut Range : 16~36mm



44AT-50AC (Angle Steel Cutter Head Adapter)

Max. Width : 50mm
Max. Thickness : 6mm



44AT-SC40 (Cable Cutter Head Adapter)

Cutting Capacity
ACSR : 40mm
Copper : 44mm



44AP-MM36 (Nut Splitting Head)

Bolt Range : M10~M26
Hex. Nut Range : 36mm



■ **Model No. LEC-240** (with Li-ion Battery & Charger)

Height : 327 mm

Weight : 5.4 kgs (battery included)

■ **Specifications:**

- Drive unit : 14.4V DC Motor
- Charger (GS/CE):
- Input voltage : 110V Single Phase AC
- Input voltage : 230V Single Phase AC
- Input frequency : 50-60 Hz
- Input current : 21.75 VA
- Reservoir capacity : 145 cc

■ **Crimping Capacity:**

- Max. Pressure : 550 bar
- Max. Compression : 240 mm² copper
- Crimping force : 6.2 tons / 61 kN
- Dies sold separately (See page 152)
- (T16/25/35/50/70/95/120/150/185/240)



BATTERY OPERATED TOOLS



■ Model No. **LEC-U240** (with Li-ion Battery & Charger)

Height : 380 mm
Weight : 4.7 kgs (battery included)

■ Specifications:

Drive unit : 14.4V DC Motor
Charger (GS/CE) :
Input voltage : 110V Single Phase AC
Input voltage : 230V Single Phase AC
Input frequency : 50-60 Hz
Input current : 21.75 VA
Reservoir capacity : 120 cc

■ Crimping Capacity:

Max. Pressure : 700 bar
Max. Output : 8.8 tons / 86 kN
Ram Stroke : 14.5 mm

- Accepts BEKU type dies
- Hex. Crimping : 10-240 mm²
- Cu sleeves & lugs NFC 20. 130 : 10 to 240 mm²
- Cu or Al bare or insulated sleeve : E54 to E230
- Cu or Al sleeves & lugs DIN 48083 : KZ6 to KZ25
- Pre-rounding : 35 to 240 mm²
- Dies sold separately (See page 155)

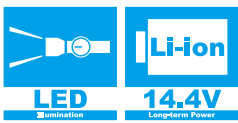

Accepts all dies used by Alcoa, Burndy, T&B, Klauke, Cembre and Blackburn 12 ton U-type dies. Suitable for TERMINALS with wall thickness little less than DIN 46235 cable lugs.

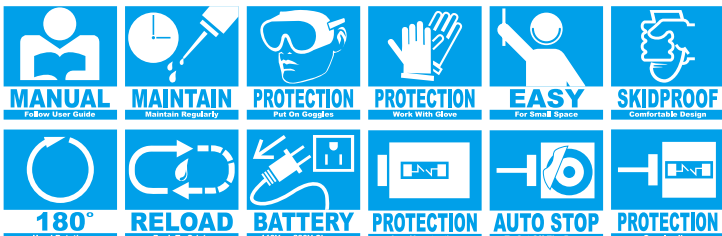

■ **Model No. LEC-6FT** (with Li-ion Battery & Charger)

Height : 400 mm

Weight : 6.4 kgs (battery included)

■ **Specifications:**

Drive unit : 14.4V DC Motor

Charger (GS/CE):

Input voltage : 110V Single Phase AC

Input voltage : 230V Single Phase AC

Input frequency : 50-60 Hz

Input current : 21.75 VA

Reservoir capacity : 120 cc

■ **Crimping Capacity:**

Max. Pressure : 700 bar

Jaw Opening : 38 mm

Oil Required : 29 cc

Crimping force : 6.4 tons / 62 kN

Main Application :

Anderson type connectors up to 750 MCM

■ **Features:**

- 360° rotating head for convenient operation.
- Dieless compression to crimp Anderson style connectors up to 750 MCM.



BATTERY OPERATED TOOLS

■ Model No. **LEC-6** (with Li-ion Battery & Charger)

Height : 386 mm

Weight : 6.2 kgs (battery included)

■ Specifications:

Drive unit : 14.4V DC Motor

Charger (GS/CE):

Input voltage : 110V Single Phase AC

Input voltage : 230V Single Phase AC

Input frequency : 50-60 Hz

Input current : 21.75 VA

Reservoir capacity : 120 cc

■ Crimping Capacity:

Max. Pressure : 700 bar

Jaw Opening : 35.8 mm

Oil Required : 26.6 cc

Crimping force : 6.4 tons / 62 kN

Main Application :

Anderson type connectors up to 500 MCM

■ Features:

- 360° rotating head for convenient operation.
- Dieless compression to crimp Anderson style connectors up to 500 MCM.



- Insulated cap should be ordered separately.

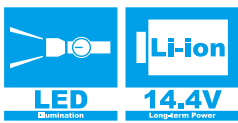

■ **Model No. LEC-S24** (with Li-ion Battery & Charger)

Length : 328 mm

Weight : 6.0 kgs (battery included)

■ **Specifications:**

- Drive unit : 14.4V DC Motor
- Charger (GS/CE):
- Input voltage : 110V Single Phase AC
- Input voltage : 230V Single Phase AC
- Input frequency : 50-60 Hz
- Input current : 21.75 VA
- Reservoir capacity : 145 cc

■ **Cutting Capacity:**

- Max. Pressure : 700 bar
- Oil Required : 32 cc
- Max. Output : 8 tons / 78.4 kN
- Wire rope 6x7 : 18 mm
- Wire rope 6x12 : 24 mm
- Wire rope 6x19 : 24 mm
- Soft steel bar : 20 mm
- Reinforcing rod : 16 mm
- Cu Strands : 24 mm
- Al Strands : 24 mm
- ACSR : 24 mm
- Guy wire 1x7 : 20 mm
- Guy wire 1x19 : 20 mm

Cutting of piano wire is prohibited.

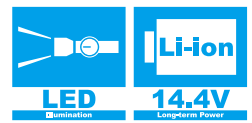

BATTERY OPERATED TOOLS

■ Model No. **LEC-S45** (with Li-ion Battery & Charger)

Height : 328 mm

Weight : 7.1 kgs (battery included)

■ Specifications:

Drive unit : 14.4V DC Motor

Charger (GS/CE):

Input voltage : 110V Single Phase AC

Input voltage : 230V Single Phase AC

Input frequency : 50-60 Hz

Input current : 21.75 VA

Reservoir capacity : 120 cc

■ Cutting Capacity:

Max. Pressure : 700 bar

Oil Required : 71 cc

Max. Output : 9.7 tons / 96 kN

Wire rope 6x7 : 40 mm

Wire rope 6x12 : 40 mm

Wire rope 6x19 : 40 mm

Soft copper bar : 32 mm

Soft aluminum bar : 40 mm

Soft steel bar : 20 mm

Cu strands : 40 mm

Al strands : 40 mm

ACSR : 40 mm

Cutting of piano wire is prohibited.

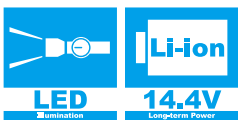

■ **Model No. LEC-S55** (with Li-ion Battery & Charger)

Length : 479 mm

Weight : 9.2 kgs (battery included)

■ **Specifications:**

- Drive unit : 14.4V DC Motor
- Charger (GS/CE):
- Input voltage : 110V Single Phase AC
- Input voltage : 230V Single Phase AC
- Input frequency : 50-60 Hz
- Input current : 21.75 VA
- Reservoir capacity : 120 cc

■ **Cutting Capacity:**

- Max. Pressure : 700 bar
- Oil Required : 106.6 cc
- Max. Output : 12.7 tons / 125 kN
- Wire rope 6x7 : 25 mm
- Wire rope 6x12 : 30 mm
- Wire rope 6x19 : 30 mm
- Soft copper bar : 35 mm
- Soft aluminium bar : 28 mm
- Soft steel bar : 22 mm
- Reinforcing rod : 19 mm
- Cu strands : 54 mm
- Al strands : 54 mm
- ACSR : 54 mm
- Guy wire 1x7 : 15 mm
- Guy wire 1x19 : 20 mm
- Underground cable : 50 mm

Cutting of piano wire is prohibited.

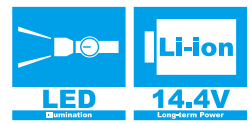

BATTERY OPERATED TOOLS

■ Model No. **LEC-C85** (with Li-ion Battery & Charger)

Height : 345 mm

Weight : 8.0 kgs (battery included)

■ Specifications:

Drive unit : 14.4V DC Motor

Charger (GS/CE):

Input voltage : 110V Single Phase AC

Input voltage : 230V Single Phase AC

Input frequency : 50-60 Hz

Input current : 21.75 VA

Reservoir capacity : 120 cc

■ Cutting Capacity:

Max. Pressure : 700 bar

Oil Required : 75 cc

Max. Output : 5.6 tons / 56 kN

Material : Copper and
aluminum cables

Maximum size : \varnothing 85 mm

Cutting of piano wire is prohibited.

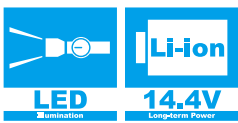

■ **Model No. LEC-30A** (with Li-ion Battery & Charger)

Height : 418 mm
Weight : 5.2 kgs (battery included)

■ **Specifications:**

Drive unit : 14.4V DC Motor
Charger (GS/CE):
Input voltage : 110V Single Phase AC
Input voltage : 230V Single Phase AC
Input frequency : 50-60 Hz
Input current : 21.75 VA
Reservoir capacity : 120 cc

■ **Cutting Capacity:**

Max. Pressure : 700 bar
Max. Output : 7.9 tons / 77.8 kN
Oil Required : 23 cc
Cu Strands : 28 mm
Al Strands : 28 mm
ACSR : 19 mm
Telephone Cable : 30 mm
CCP Cable : 30 mm
Underground Cable : 30 mm
Cutting of piano wire is prohibited.



Bare Strands	ACSR Cable	GUY WIRE	Soft Steel Bar	CU / AL	MANUAL Follow User Guide	MAINTAIN Maintain Regularly	PROTECTION Put On Goggles	PROTECTION Work With Glove	EASY For Small Space	SKIDPROOF Comfortable Design	LED Illumination	14.4V Long-term Power
180° Head Rotation	RELOAD Back To Origin	BATTERY 110V or 230V Charger	PROTECTION Low V protection	AUTO STOP To Cut Off The Power	PROTECTION Overloading	180° Head Rotation	RELOAD Back To Origin	BATTERY 110V or 230V Charger	PROTECTION Low V protection	AUTO STOP To Cut Off The Power	PROTECTION Overloading	

BATTERY OPERATED TOOLS

■ Model No. **LEC-85YC** (with Li-ion Battery & Charger)

Length : 516 mm

Weight : 8.0 kgs (battery included)

■ Specifications:

Drive unit : 14.4V DC Motor
 Charger (GS/CE):
 Input voltage : 110V Single Phase AC
 Input voltage : 230V Single Phase AC
 Input frequency : 50-60 Hz
 Input current : 21.75 VA
 Reservoir capacity : 120 cc

■ Cutting Capacity:

Max. Pressure : 700 bar
 Max. Output : 8 tons / 78.4 kN
 Cu strands : 60 mm
 Al strands : 60 mm
 CCP cable : 85 mm
 (Note : Tensile strength (daN/mm²) \leq 180)

Cutting of piano wire is prohibited.



■ **Model No. REC-50** (with Ni-cd Battery & Charger)

Height : 345 mm

Weight : 2.5 kgs

■ **Cutting Capacity:**

- Max. Cable diameter:
Nonferrous 50 mm

■ **Specifications:**

Drive unit : 12V DC Motor

Charger (GS/CE):

Input voltage : **REC-50-120**

120V Single Phase AC

Input voltage : **REC-50-230**

230V Single Phase AC

Input frequency : 50-60 Hz

Input current : 21.75 VA

■ **Accessories:**

- KuDos plastic carrying case
- 12V Battery , 110V or 230V Charger
(See page 77)



※ For reference only

Model No.	Specification
	600V-CV325 mm ² (31 mm OD)
Polyethylene cable	600V-CV150 mm ² x 3(46 mm OD)
	600V-CV500 mm ² (38 mm OD)
	6KV-CVT500 mm ² (45 mm OD)
Multi-core vinyl insulation cable	VVR150 mm ² (47 mm OD) 3 core
Soft copper cable	IV500 mm ² (35 mm OD)
Hard copper cable	150 mm ² (21 mm OD)



■ Model No. **LEC-50** (with Li-ion Battery & Charger)

Height : 313 mm

Weight : 2.4 kgs

■ Cutting Capacity:

- Max. Cable diameter:
Nonferrous 50 mm

■ Specifications:

Drive unit : 14.4V DC Motor

Charger (BOSCH):

Input voltage: **LEC-50-120**

110V Single Phase AC

Input voltage: **LEC-50-230**

230V Single Phase AC

Input frequency: 50-60 Hz

Input current : 21.75 VA

■ Accessories:

- KuDos plastic carrying case
- 14.4V Battery , 110V or 230V Charger
(See page 77)



※ For reference only

Model No.	Specification
	600V-CV325 mm ² (31 mm OD)
Polyethylene cable	600V-CV150 mm ² x 3(46 mm OD)
	600V-CV500 mm ² (38 mm OD)
	6KV-CVT500 mm ² (45 mm OD)
Multi-core vinyl insulation cable	VVR150 mm ² (47 mm OD) 3 core
Soft copper cable	IV500 mm ² (35 mm OD)
Hard copper cable	150 mm ² (21 mm OD)



■ **Model No. REC-54** (with Ni-cd Battery & Charger)

Height : 360 mm

Weight : 4.0 kgs

■ **Crimping Capacity:**

- Max. Cable diameter:
Nonferrous 54 mm & Steel supported
400-pair telecom cable

■ **Specifications:**

Drive unit : 14.4V DC Motor

Charger (GS/CE):

Input voltage : **REC-54-120**

120V Single Phase AC

Input voltage : **REC-54-230**

230V Single Phase AC

Input frequency : 50-60 Hz

Input current : 21.75 VA

■ **Accessories:**

- KuDos plastic carrying case
- 14.4V Battery, 110V or 230V Charger
(See page 77)



※ For reference only

Model No.	Specification
Polyethylene cable	600V-CV325 mm ² (31 mm OD)
Multi-core vinyl insulation cable	VVR150 mm ² (47 mm OD) 3 core
SB-ACSR	ACSR120 mm ² (18.6 mm OD) ACSR shall under steel of 2.0mm
Hard aluminum cable	HAL-OC400 mm ² (31.9mm OD)
Hard copper cable	OE-OC150 mm ² (21 mm OD)
SS cable	0.4 mm 400 CCP-F-SS(CR) cable

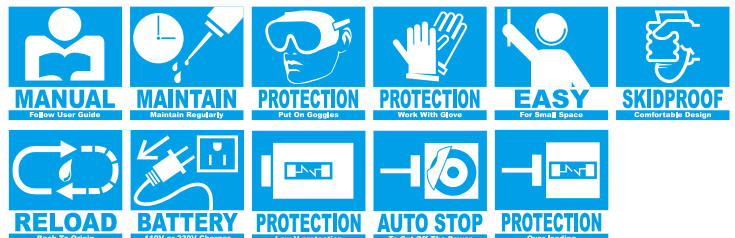
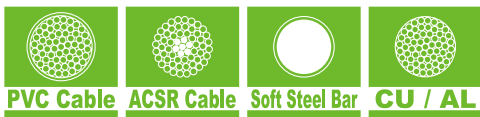

■ Model No. **LEC-54** (with Li-ion Battery & Charger)

Height : 326 mm

Weight : 3.0 kgs

■ Cutting Capacity:

- Max. Cable diameter:
Nonferrous 54 mm & Steel supported
400-pair telecom cable

■ Specifications:

Drive unit : 14.4V DC Motor

Charger (BOSCH):

Input voltage: **LEC-54-120**

120V Single Phase AC

Input voltage: **LEC-54-230**

230V Single Phase AC

Input frequency : 50-60 Hz

Input current : 21.75 VA

■ Accessories:

- KuDos plastic carrying case
- 14.4V Battery , 110V or 230V Charger
(See page 77)



※ For reference only

Model No.	Specification
Polyethylene cable	600V-CV325 mm ² (31 mm OD)
Multi-core vinyl insulation cable	VVR150 mm ² (47 mm OD) 3 core
SB-ACSR	ACSR120 mm ² (18.6 mm OD) ACSR shall under steel of 2.0mm
Hard aluminum cable	HAL-OC400 mm ² (31.9mm OD)
Hard copper cable	OE-OC150 mm ² (21 mm OD)
SS cable	0.4 mm 400 CCP-F-SS(CR) cable

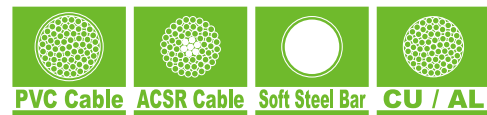

■ **Model No. REC-54AC** (with Ni-cd Battery & Charger)

Height : 360 mm

Weight : 4.0 kgs

■ **Cutting Capacity:**

- Max. Cable diameter:
Nonferrous 54 mm

■ **Specifications:**

Drive unit : 14.4V DC Motor

Charger (GS/CE):

Input voltage : **REC-54AC-120**

120V Single Phase AC

Input voltage : **REC-54AC-230**

230V Single Phase AC

Input frequency : 50-60 Hz

Input current : 21.75 VA

■ **Accessories:**

- KuDos plastic carrying case
- 14.4V Battery, 110V or 230V Charger
(See page 77)



※ For reference only

Model No.	Specification
Polyethylene cable	600V-CV325 mm ² (31 mm OD)
	600V-CV150 mm ² (46 mm OD) 3 core
	600V-CV500 mm ² (38 mm OD)
	6KV-CVT500 mm ² (45 mm OD)
Multi-core vinyl insulation cable	VVR150 mm ² (47 mm OD) 3 core
Soft copper cable	IV500 mm ² (35 mm OD)
Hard copper cable	150 mm ² (21 mm OD)



■ Model No. **LEC-54AC** (with Li-ion Battery & Charger)

Height : 390 mm

Weight : 3.4 kgs

■ Cutting Capacity:

- Max. Cable diameter:
Nonferrous 54 mm

■ Specifications:

Drive unit : 14.4V DC Motor

Charger (BOSCH):

Input voltage : **LEC-54AC-120**

110V Single Phase AC

Input voltage : **LEC-54AC-230**

230V Single Phase AC

Input frequency : 50-60 Hz

Input current : 21.75 VA

■ Accessories:

- KuDos plastic carrying case
- 14.4V Battery, 110V or 230V Charger
(See page 77)



※ For reference only

Model No.	Specification
	600V-CV325 mm ² (31 mm OD)
Polyethylene cable	600V-CV150 mm ² x 3(46 mm OD)
	600V-CV500 mm ² (38 mm OD)
	6KV-CVT500 mm ² (45 mm OD)
Multi-core vinyl insulation cable	VVR150 mm ² (47 mm OD) 3 core
Soft copper cable	IV500 mm ² (35 mm OD)
Hard copper cable	150 mm ² (21 mm OD)



■ **Model No. REC-65** (with Ni-cd Battery & Charger)

Height : 360 mm

Weight : 4.0 kgs

■ **Cutting Capacity:**

- Max. Cable diameter:
Nonferrous 65 mm

■ **Specifications:**

Drive unit : 14.4V DC Motor

Charger (GS/CE) :

Input voltage : **REC-65-120**

120V Single Phase AC

Input voltage : **REC-65-230**

230V Single Phase AC

Input frequency : 50-60 Hz

Input current : 21.75 VA

■ **Accessories:**

- KuDos plastic carrying case
- 14.4V Battery, 110V or 230V Charger
(See page 77)



※ For reference only

Model No.	Specification
Polyethylene cable	600V-CV325 mm ² (31 mm OD)
	600V-CV150 mm ² (46 mm OD) 3 core
	600V-CV500 mm ² (38 mm OD)
	6KV-CVT500 mm ² (45 mm OD)
Multi-core vinyl insulation cable	VVR150 mm ² (47 mm OD) 3 core
Soft copper cable	IV500 mm ² (35 mm OD)
Hard copper cable	150 mm ² (21 mm OD)



■ Model No. **LEC-65** (with Ni-cd Battery & Charger)

Height: 342 mm

Weight: 2.8 kgs (battery included)

■ Cutting Capacity:

- Max. Cable diameter:
Nonferrous 65 mm

■ Specifications:

Drive unit: 14.4V DCMotor

Charger (BOCSH):

Input voltage: **LEC-65-120**

110V SinglePhaseAC

Input voltage: **LEC-65-230**

230V SinglePhaseAC

Input frequency: 50-60 Hz

Input current: 21.75 VA

■ Accessories:

- KuDos® plastic carrying case
- 14.4V Battery, 110V or 230V Charger
(See page 77)



※ For reference only

Model No.	Specification
Polyethylene cable	600V-CV325 mm ² (31 mm OD)
	600V-CV150 mm ² (46 mm OD) 3 core
	600V-CV500 mm ² (38 mm OD)
	6KV-CVT500 mm ² (45 mm OD)
Multi-core vinyl insulation cable	VVR150 mm ² (47 mm OD) 3 core
Soft copper cable	IV500 mm ² (35 mm OD)
Hard copper cable	150 mm ² (21 mm OD)



■ **Model No. REC-85CCP** (with Ni-cd Battery & Charger)

Height : 360 mm

Weight : 4.0 kgs

■ **Cutting Capacity:**

- Max. Cable diameter:
85 mm CCP cable only

■ **Specifications:**

Drive unit : 14.4V DC Motor

Charger (GS/CE) :

Input voltage : **REC-85CCP-120**

120V Single Phase AC

Input voltage : **REC-85CCP-230**

230V Single Phase AC

Input frequency : 50-60 Hz

Input current : 21.75 VA

■ **Accessories:**

- KuDos plastic carrying case
- 14.4V Battery, 110V or 230V Charger
(See page 77)



※ For reference only

Model No.	Specification
CCP cable	40-50 mm
	50-60 mm
	60-70 mm
	70-80 mm



■ Close View of NEW KC series Features

● Gear rotated blade design.

BRUSH DESIGN

● It can anti-dust & prevent impurities in the machine.



SWITCH

● Forward → Neutral → Backward

SAFETY SWITCH DESIGN

● Prevent missed operate the tool, It request to press both safety switch & switch to operate the tool.

● Ergonomic design and comfortable to use with anti-slip coated grip.

SWITCH

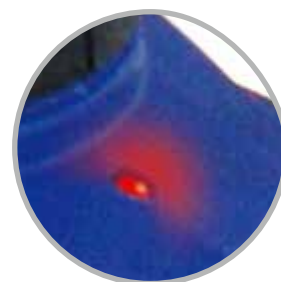

OVERLOAD INDICATOR

● When red light flashed, It shows the battery was overloaded. When out of battery, The red light will light on.



● Bosch battery power indicator 14.4V Li-ion battery.



■ **Model No. KC-54** (with Li-ion Battery & Charger)

Height : 338 mm
Weight : 3.4 kgs

■ **Cutting Capacity:**

- Max. Cable diameter:
Nonferrous 54 mm & Steel supported
400-pair telecom cable

■ **Specifications:**

Drive unit: 14.4V DC Motor
Charger (BOCSH):
Input voltage : **KC-54-120**
110V Single Phase AC
Input voltage : **KC-54-230**
230V Single Phase AC
Input frequency: 50-60 Hz
Input current: 21.75 VA

■ **Accessories:**

- KuDos plastic carrying case
- 14.4V Battery, 110V or 230V Charger
(See page 77)



※ For reference only

Model No.	Specification
Polyethylene cable	600V-CV325 mm ² (31 mm OD)
Multi-core vinyl insulation cable	VVR150 mm ² (47 mm OD) 3 core
SB-ACSR	ACSR120 mm ² (18.6 mm OD) ACSR shall under steel of 2.0mm
Hard aluminum cable	HAL-OC400 mm ² (31.9mm OD)
Hard copper cable	OE-OC150 mm ² (21 mm OD)
SS cable	0.4 mm 400 CCP-F-SS(CR) cable

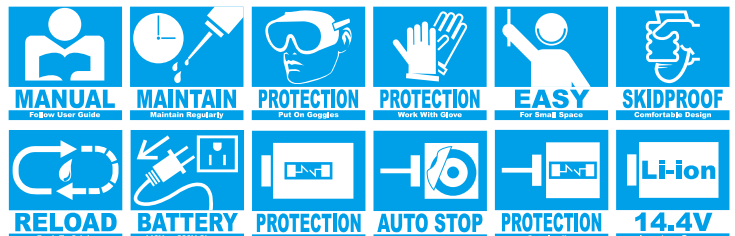
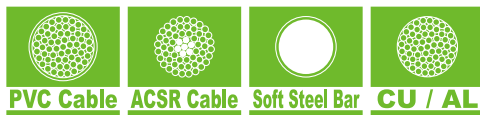



■ **Model No. KC-54AC** (with Li-ion Battery & Charger)

Height : 337 mm
Weight : 3.4 kgs

■ **Cutting Capacity:**

• Max. Cable diameter:
Nonferrous 54 mm

■ **Specifications:**

Drive unit: 14.4V DC Motor
Charger (BOCSH):
Input voltage : **KC-54AC-120**
110V Single Phase AC
Input voltage : **KC-54AC-230**
230V Single Phase AC
Input frequency: 50-60 Hz
Input current: 21.75 VA

■ **Accessories:**

- KuDos plastic carrying case
- 14.4V Battery, 110V or 230V Charger
(See page 77)



※ For reference only

Model No.	Specification
Polyethylene cable	600V-CV325 mm ² (31 mm OD)
	600V-CV150 mm ² x 3(46 mm OD)
	600V-CV500 mm ² (38 mm OD)
	6KV-CVT500 mm ² (45 mm OD)
Multi-core vinyl insulation cable	VVR150 mm ² (47 mm OD) 3 core
Soft copper cable	IV500 mm ² (35 mm OD)
Hard copper cable	150 mm ² (21 mm OD)





■ **Model No. KC-50** (with Li-ion Battery & Charger)

Height : 317 mm
Weight : 2.6 kgs

■ **Cutting Capacity:**

- Max. Cable diameter:
Nonferrous 50 mm

■ **Specifications:**

Drive unit: 14.4V DC Motor
Charger (BOCSH):
Input voltage : **KC-50-120**
110V Single Phase AC
Input voltage : **KC-50-230**
230V Single Phase AC
Input frequency: 50-60 Hz
Input current: 21.75 VA

■ **Accessories:**

- KuDos plastic carrying case
- 14.4V Battery, 110V or 230V Charger
(See page 77)

















※ For reference only

Model No.	Specification
	600V-CV325 mm ² (31 mm OD)
Polyethylene cable	600V-CV150 mm ² x 3(46 mm OD)
	600V-CV500 mm ² (38 mm OD)
	6KV-CVT500 mm ² (45 mm OD)
Multi-core vinyl insulation cable	VVR150 mm ² (47 mm OD) 3 core
Soft copper cable	IV500 mm ² (35 mm OD)
Hard copper cable	150 mm ² (21 mm OD)



■ Close View of NEW K series Features



 LED Illumination	 18V Long-term Power				
 MANUAL Follow User Guide	 MAINTAIN Maintain Regularly	 PROTECTION Put On Goggles	 PROTECTION Work With Glove	 EASY For Small Space	 SKIDPROOF Comfortable Design
 ROTATABLE Head Rotation	 RELOAD Back To Origin	 BATTERY 110V or 230V Charger	 PROTECTION Low V protection	 AUTO STOP To Cut Off The Power	 PROTECTION Check Charging



■ **Model No. K-50** (with Li-ion Battery & Charger)

Length : 427 mm / Wt.: 3.5 kgs(w/o battery)
Weight : 3.9 kgs (2.0Ah battery included)

■ **Specifications:**

Drive unit: 18V DC Motor
Charger (GS/CE):
Input voltage : 110V Single Phase AC
Input voltage : 230V Single Phase AC
Input frequency : 50-60 Hz
Reservoir capacity : 48 cc

■ **Crimping Capacity:**

Max. Pressure : 520 bar
Max Output : 5 tons / 49 kN
Crimping Die Sets As Below
(Sold Separately)



※ Above pressing jaws are sold separately.



<p>LED Illumination</p>		<p>Li-ion Long-term Power</p>	
<p>MANUAL Follow User Guide</p>	<p>MAINTAIN Maintain Regularly</p>	<p>PROTECTION Put On Goggles</p>	<p>PROTECTION Work With Glove</p>
<p>EASY For Small Space</p>	<p>SKIDPROOF Comfortable Design</p>	<p>350° Head Rotation</p>	<p>RELOAD Back To Origin</p>
<p>BATTERY 110V or 230V Charger</p>	<p>PROTECTION Low V protection</p>	<p>AUTO STOP To Cut Off The Power</p>	<p>PROTECTION Overloading</p>

■ Model No. **K-50 Die Set**

Weight : 3.0 kgs

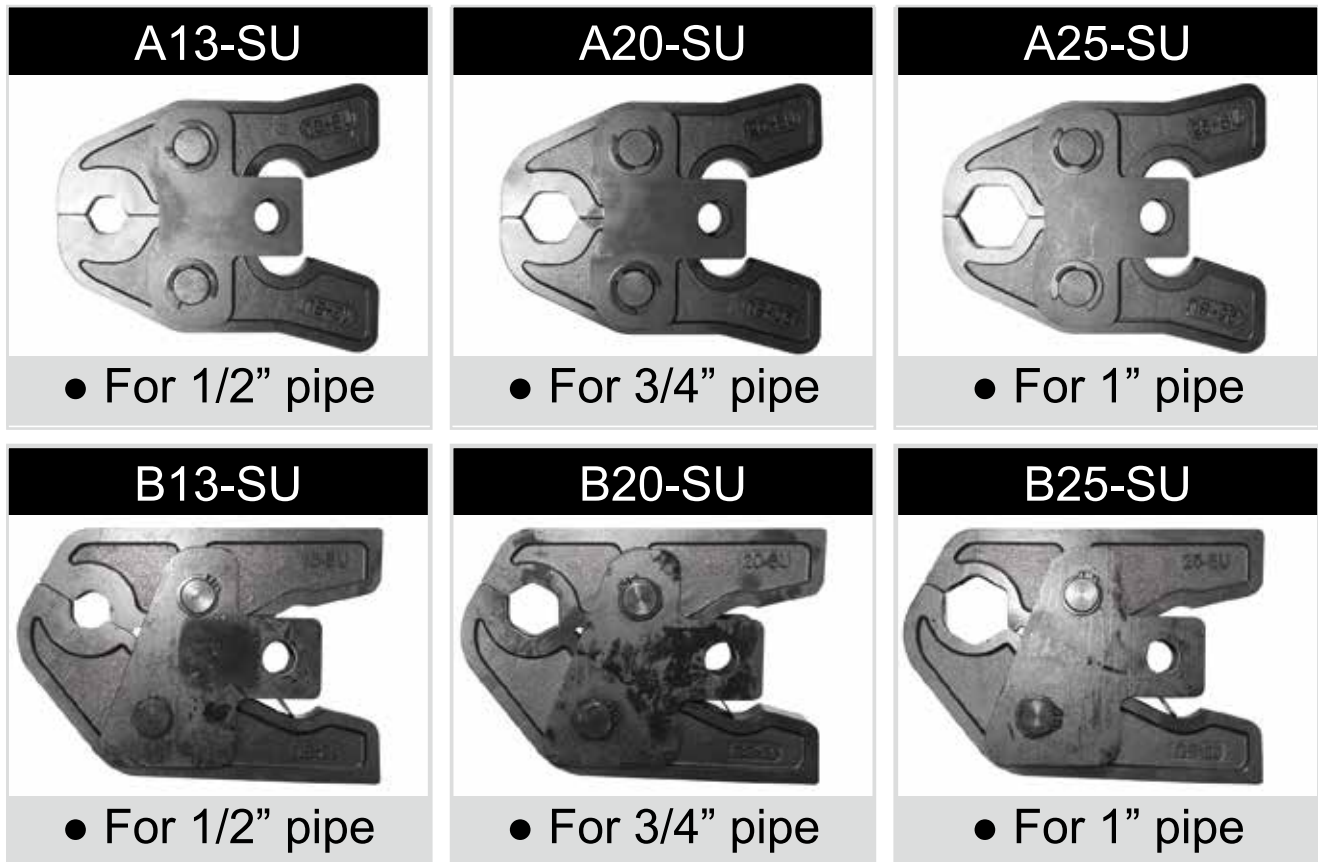

※(Standard JIS G3448)

■ Exchange The Die Set Operate Procedure





■ Model No. **K-150** (with Li-ion Battery & Charger)

Length: 328 mm / Wt.: 1.9 kgs(w/o battery)

Weight: 2.3 kgs (2.0Ah battery included)

■ Specifications:

Drive unit: 18V DC Motor

Charger (GS/CE):

Input voltage : 110V Single Phase AC

Input voltage : 230V Single Phase AC

Input frequency : 50-60 Hz

Reservoir capacity : 48 cc

■ Crimping Capacity:

Max. Pressure: 420 bar

Max Output: 4.0 tons / 39 kN

Max. Compression: 150 mm² copper

Accepts BEKU type dies

Stock Dies are for DIN 46235 Terminals

Dies sold separately

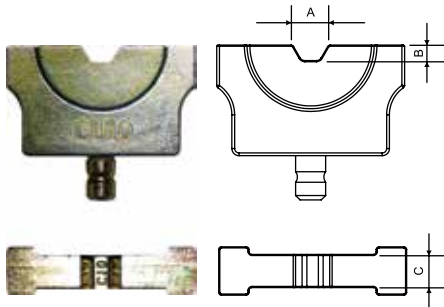

DIE NO.	A	B	C	Unit : mm
K150-CU-6	5.7	2.5	6.0	
K150-CU-10	6.4	2.8	6.0	
K150-CU-16	7.1	3.1	6.0	
K150-CU-25	8.7	3.8	6.0	
K150-CU-35	10.6	4.6	6.0	
K150-CU-50	12.0	5.2	6.0	
K150-CU-70	13.3	5.8	6.0	
K150-CU-95	16.4	7.1	6.0	
K150-CU-120	18.9	8.2	6.0	
K150-CU-150	21.0	9.1	6.0	

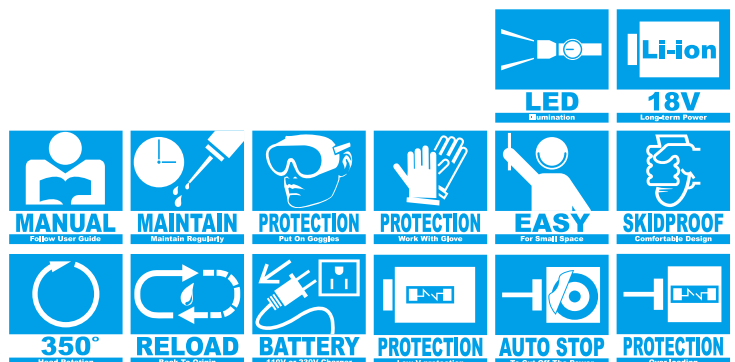

BATTERY OPERATED TOOLS

■ Model No. **K-BGD3** (with Li-ion Battery & Charger)

Length : 459 mm / Wt.: 3.0 kgs(w/o battery)
Weight : 3.4 kgs (2.0Ah battery included)

■ Specifications:

Drive unit: 18V DC Motor
Charger (GS/CE):
Input voltage : 110V Single Phase AC
Input voltage : 230V Single Phase AC
Input frequency : 50-60 Hz
Reservoir capacity : 40 cc

■ Crimping Capacity:

Max. Pressure : 460 bar
Max. Output : 6 tons / 58 kN

■ Features:

- Proper crimps are assured with butting steel jaws.
- Increased strength and greater bearing area is provided with larger steel bolts.
- Fast, easy, one-hand die insertion.
- No lost dies with spring loaded positive lock die retainer buttons.
- Full crimp force assured with over center cam action.
- Operator protection provided with butt stops and heat shrinktubing.
- Long life expectancy provided with fiberglass handles and light weight high strength aluminum alloy castings.
- The "D3" groove accommodates the line of type "W"-die inserts.

■ Connector Range:

- Copper, Aluminum, ACSR, Copperweld, Alumoweld, Steel, 6201, 5005, Compressed and Compact conductors.
- Copper Taps: # 10 sol.-2/0 str.
- Aluminum, ACSR Taps: # 14 sol. -4/0 ACSR
- Stirrups: # 6 ACSR-4/0 ACSR
- Overhead Full Tension Deadend, Full Tension Splices, Non Tension Splices, and Terminals Conductor Range: # 10 str. -4/0 ACSR
- Code conductor connectors: # 6-4/0 str. Copper and Aluminum

KuDos KW-dies	Burndy W-Dies	KuDos KW-dies	Burndy W-Dies
KW-BG	W-BG	KW-165	W-165
KW-O	W-O	KW-166	W-166
KW-C	W-C	KW-171	W-171
KW-K840	W-K840	KW-237	W-237
KW-161	W-161	KW-243	W-243
KW-162	W-162	KW-247	W-247
KW-163	W-163	KW-249	W-249
KW-164	W-164	KW-702	W-702

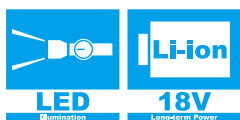



■ **Model No. K-10C** (with Li-ion Battery & Charger)

Length: 333 mm / Wt.: 1.5 kgs(w/o battery)
Weight: 1.9 kgs (2.0Ah battery included)

■ **Specifications:**

Drive unit: 18V DC Motor
Charger (GS/CE):
Input voltage : 110V Single Phase AC
Input voltage : 230V Single Phase AC
Input frequency : 50-60 Hz
Reservoir capacity : 40 cc

■ **Crimping Capacity:**

Max. Pressure: 380 bar
Max Output: 1.5 tons / 14.7 kN

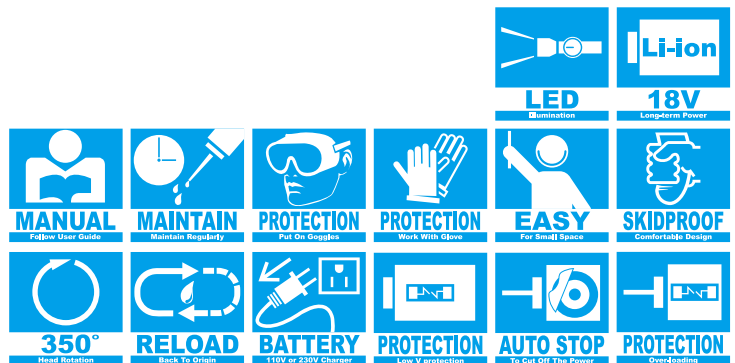

BATTERY OPERATED TOOLS

■ Model No. **K-120** (with Li-ion Battery & Charger)

Length: 356 mm / Wt.: 2.3 kgs(w/o battery)

Weight: 2.7 kgs (2.0Ah battery included)



■ Specifications:

Drive unit: 18V DC Motor

Charger (GS/CE):

Input voltage : 110V Single Phase AC

Input voltage : 230V Single Phase AC

Input frequency : 50-60 Hz

Reservoir capacity : 40 cc

■ Crimping Capacity:

Max. Pressure: 700 bar

Max Output: 2.7 tons / 26.5N

Max. Compression: 16 mm² ~ 120 mm² copper

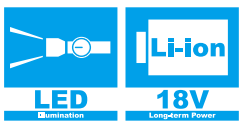



■ **Model No. K-ED10** (with Li-ion Battery & Charger)

Length: 410 mm / Wt.: 3.5 kgs(w/o battery)
Weight: 3.9 kgs (2.0Ah battery included)

■ **Specifications:**

Drive unit: 18V DC Motor
Charger (GS/CE):
Input voltage : 110V Single Phase AC
Input voltage : 230V Single Phase AC
Input frequency : 50-60 Hz
Reservoir capacity : 48 cc

■ **Crimping Capacity:**

Max. Pressure: 700 bar
Max Output: 6.7 tons / 78.4N



<p>LED Illumination</p>		<p>Li-ion 18V Long-term Power</p>	
<p>MANUAL Follow User Guide</p>	<p>MAINTAIN Maintain Regularly</p>	<p>PROTECTION Put On Goggles</p>	<p>PROTECTION Work With Glove</p>
<p>EASY For Small Space</p>	<p>SKIDPROOF Comfortable Design</p>	<p>350° Head Rotation</p>	<p>RELOAD Back To Origin</p>
<p>BATTERY 110V or 230V Charger</p>	<p>PROTECTION Low V protection</p>	<p>PROTECTION Overheating</p>	

■ Model No. **K-ED10 (Related heads)**



KED10-PM Hole Punch Adapter

Ram Stroke: 25mm
Max. Output: 6.7tons/66kN
Draw Stud (3/4")



KED10-RC Cutting Dies For DIN Rails

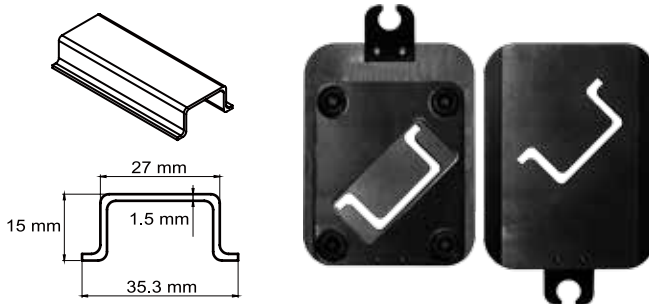

KED10-CR-12 Adapter For Crimping Dies

Extra optional adapters :
• KED10-CR-5
• KED10-CR-9

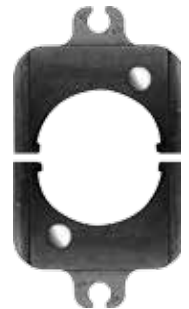

KED10-BC85 Railway Cutter For BC - Style Catenary Wires

Head in 4 sizes :
• 85 mm²
• 110 mm²
• 120 mm²
• 150 mm²



KED10-TRM5 Cutting Dies For Threaded Rods

Head in 8 types :
• M5 x 0.8
• M6 x 1.0
• M8 x 1.25
• M10 x 1.5
• M12 x 1.5
• 1/4"-20
• 3/8"-16
• 1/2"-13



KED10-NYY Cutting Dies For Cutting Multi-Stranded Cu And Al Conductors Without Armouring

In conjunction with
K-ED10 is max. 25 mm dia



KED10-ACSR ACSR Cutting Die For Al/Cu Conductors

In conjunction with
K-ED10 is max. 25 mm dia

For ACSR conductors to
DIN EN DIN 48204 and
high-tensile steel cables



※ Available for 7 interchangeable adapters and continuous with more optional adapters under developing will be coming soon !

■ **Model No. K-185** (with Li-ion Battery & Charger)

Length: 360 mm / Wt.: 2.1 kgs(w/o battery)

Weight: 2.5 kgs (2.0Ah battery included)

■ **Specifications:**

Drive unit: 18V DC Motor

Charger (GS/CE):

Input voltage : 110V Single Phase AC

Input voltage : 230V Single Phase AC

Input frequency : 50-60 Hz

Reservoir capacity : 48 cc

■ **Crimping Capacity:**

Max. Pressure: 460 bar

Max Output: 5.3 tons / 52 kN

Max. Compression: 185 mm² copper

Accepts BEKU type dies

Stock Dies are for DIN 46235 Terminals

Dies sold separately (See page 151)

(AHE 1016/2535/5070/95120/150/185)

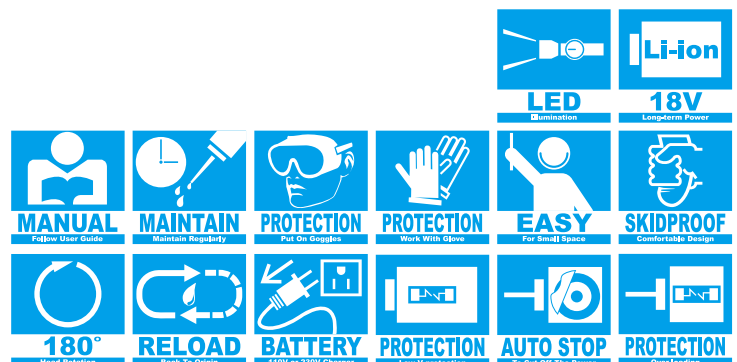

■ Model No. **K-240** (with Li-ion Battery & Charger)

Length: 354 mm / Wt.: 2.3 kgs(w/o battery)

Weight: 2.7 kgs (2.0Ah battery included)

■ Specifications:

Drive unit: 18V DC Motor

Charger (GS/CE):

Input voltage : 110V Single Phase AC

Input voltage : 230V Single Phase AC

Input frequency : 50-60 Hz

Reservoir capacity : 48 cc

■ Crimping Capacity:

Max. Pressure: 460 bar

Max Output: 5.3 tons / 52 kN

Max. Compression: 240 mm² copper

Accepts BEKU type dies

Stock Dies are for DIN 46235 Terminals

Dies sold separately (See page 151)

(AHE 1016/2535/5070/95120/150/185/240)

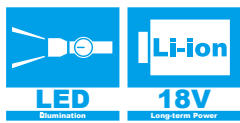

■ **Model No. K-PH240** (with Li-ion Battery & Charger)

Length: 359 mm / Wt.: 2.9 kgs(w/o battery)

Weight: 3.3 kgs (2.0Ah battery included)

■ **Specifications:**

Drive unit: 18V DC Motor

Charger (GS/CE):

Input voltage : 110V Single Phase AC

Input voltage : 230V Single Phase AC

Input frequency : 50-60 Hz

Reservoir capacity : 48 cc

■ **Crimping Capacity:**

Max. Pressure: 550 bar

Max Output: 6.2 tons / 61 kN

Max. Compression: 240 mm² copper
Aluminum lugs

Accepts all dies used for Alcoa,
Burndy, T&B, Klauke, Cembre and
Blackburn 6 ton compressors

Dies sold separately (See page 152)
(T16/25/35/50/70/95/120/150/185/240)

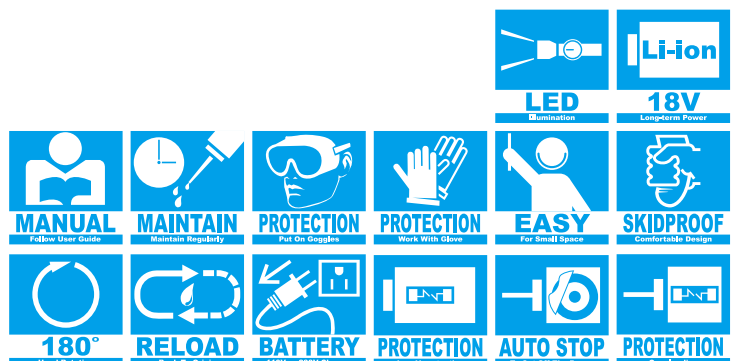

■ Model No. **K-20** (with Li-ion Battery & Charger)

Length : 329 mm / Wt.: 2.8 kgs(w/o battery)
Weight : 3.2 kgs (2.0Ah battery included)

■ Specifications:

Drive unit: 18V DC Motor
Charger (GS/CE):
Input voltage : 110V Single Phase AC
Input voltage : 230V Single Phase AC
Input frequency : 50-60 Hz
Reservoir capacity : 48 cc

■ Cutting Capacity:

Max. Pressure : 550 bar
Oil Required : 24 cc
Max. Output : 5.3 tons / 51.9 kN
Wire rope 6x7 : 16 mm
Wire rope 6x12 : 20 mm
Wire rope 6x19 : 20 mm
Soft Copper bar : 20 mm
Soft aluminum bar : 16 mm
Soft steel bar : 16 mm
Reinforcing rod : 13 mm
Cu strands : 20 mm
Al strands : 20 mm
ACSR Cable : 21 mm
Guy wire 1x7 : 15 mm
Guy wire 1x19 : 16 mm
underground cable : 18 mm

Cutting of piano wire is prohibited.

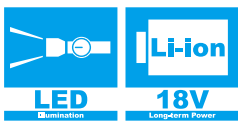

■ **Model No. K-24** (with Li-ion Battery & Charger)

Length : 344 mm / Wt.: 2.8 kgs(w/o battery)
Weight : 3.2 kgs (2.0Ah battery included)

■ **Specifications:**

Drive unit: 18V DC Motor
Charger (GS/CE):
Input voltage : 110V Single Phase AC
Input voltage : 230V Single Phase AC
Input frequency : 50-60 Hz
Reservoir capacity : 48 cc

■ **Cutting Capacity:**

Max. Pressure : 700 bar
Oil Required : 25 cc
Max. Output : 6.7 tons / 78.4 kN
Wire rope 6x7 : 24 mm
Wire rope 6x12 : 24 mm
Wire rope 6x19 : 24 mm
Soft Copper bar : 23 mm
Soft aluminum bar : 24 mm
Soft steel bar : 16 mm
Cu strands : 24 mm
Al strands : 24 mm
ACSR : 24 mm

Cutting of piano wire is prohibited.

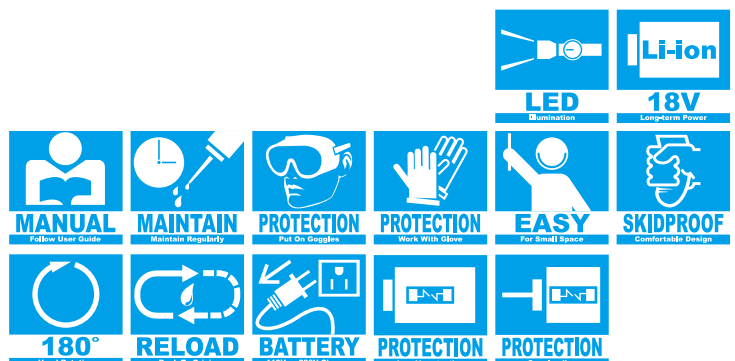
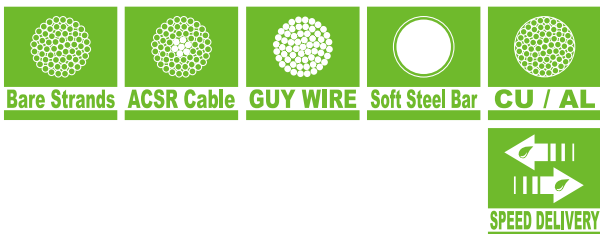

■ Model No. **K-S24** (with Li-ion Battery & Charger)

Length : 356 mm / Wt.: 3.7 kgs(w/o battery)
Weight : 4.1 kgs (2.0Ah battery included)

■ Specifications:

Drive unit: 18V DC Motor
Charger (GS/CE):
Input voltage : 110V Single Phase AC
Input voltage : 230V Single Phase AC
Input frequency : 50-60 Hz
Reservoir capacity : 48 cc

■ Cutting Capacity:

Max. Pressure : 700 bar
Oil Required : 31 cc
Max Output : 6.7 tons / 78.4 kN
Wire rope 6x7 : 18 mm
Wire rope 6x12 : 24 mm
Wire rope 6x19 : 24 mm
Soft steel bar : 20 mm
Reinforcing rod : 16 mm
Cu strands : 24 mm
Al strands : 24 mm
ACSR Cable : 24 mm
Guy wire 1x7 : 20 mm
Guy wire 1x19 : 20 mm
Cutting of piano wire is prohibited.

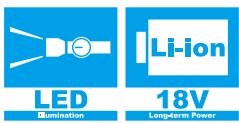

■ **Model No. K-30A** (with Li-ion Battery & Charger)

Length : 412 mm / Wt.: 3.6 kgs(w/o battery)
Weight : 4.0 kgs (2.0Ah battery included)



■ **Specifications:**

Drive unit: 18V DC Motor
Charger (GS/CE):
Input voltage : 110V Single Phase AC
Input voltage : 230V Single Phase AC
Input frequency : 50-60 Hz
Reservoir capacity : 48 cc

■ **Cutting Capacity:**

Max. Pressure : 700 bar
Max. Output : 7.9 tons / 778 kN
Cu Strands : 28 mm
Al Strands : 28 mm
ACSR : 19 mm
Telephone Cable : 30 mm
CCP Cable : 30 mm
Underground Cable : 30 mm
Cutting of piano wire is prohibited.

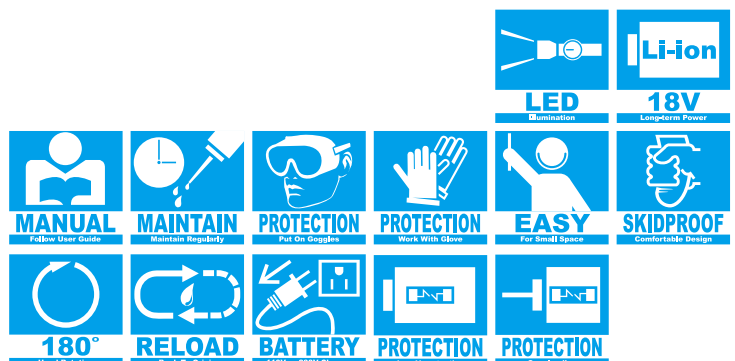
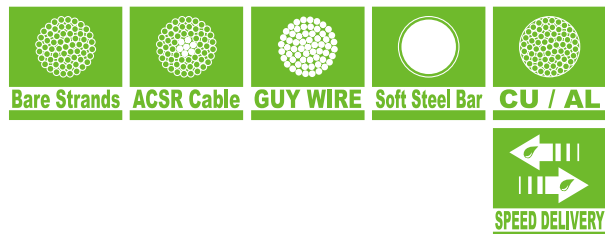

BATTERIES

■ Model No. **BAT-12V**

■ Specifications:

Output voltage : 12V
Capacity : 1.2 Ah

■ Use for:

REC-50



■ Model No. **BAT-14.4V**

■ Specifications:

Output voltage : 14.4V
Capacity : 2.0 Ah

■ Use for:

REC-54
REC-54AC
REC-65
REC-85CCP



■ Model No. **LEC-14.4V**

■ Specifications:

Output voltage : 14.4V
Capacity : 3.0 Ah

■ Use for:

LEC-series



■ Model No. **K-18V**

■ Specifications:

Output voltage : 18V
Capacity : 2.0 Ah \ 4.0 Ah

■ Use for:

K-series
CEP-15SS



CHARGERS

■ Model No. **ABC-10A**

■ Specifications:

Input voltage : 115V AC 50-60Hz 40W
Output : 15V DC 1.5A

■ Use for:

BAT-12V

■ Model No. **AD-B735**

■ Specifications:

Input voltage : 120V AC 50-60Hz 40W
Output : 18V DC 1.5A

■ Use for:

BAT-14.4V

■ Model No. **LEC-110CHA**

■ Specifications:

Input voltage : 115V AC 50-60Hz 140W
Output : 10.8V DC 6A

■ Use for:

LEC-14.4V \ K-18V

■ Model No. **ABC-10B**

■ Specifications:

Input voltage : 230V AC 50-60Hz 40W
Output : 15V DC 1.5A

■ Use for:

BAT-12V

■ Model No. **AD-B734**

■ Specifications:

Input voltage : 230V AC 50-60Hz 40W
Output : 18V DC 1.5A

■ Use for:

BAT-14.4V

■ Model No. **LEC-230CHA**

■ Specifications:

Input voltage : 220V~240V AC 50-60Hz 140W
Output : 10.8V~18V DC 6A

■ Use for:

LEC-14.4V \ K-18V

